

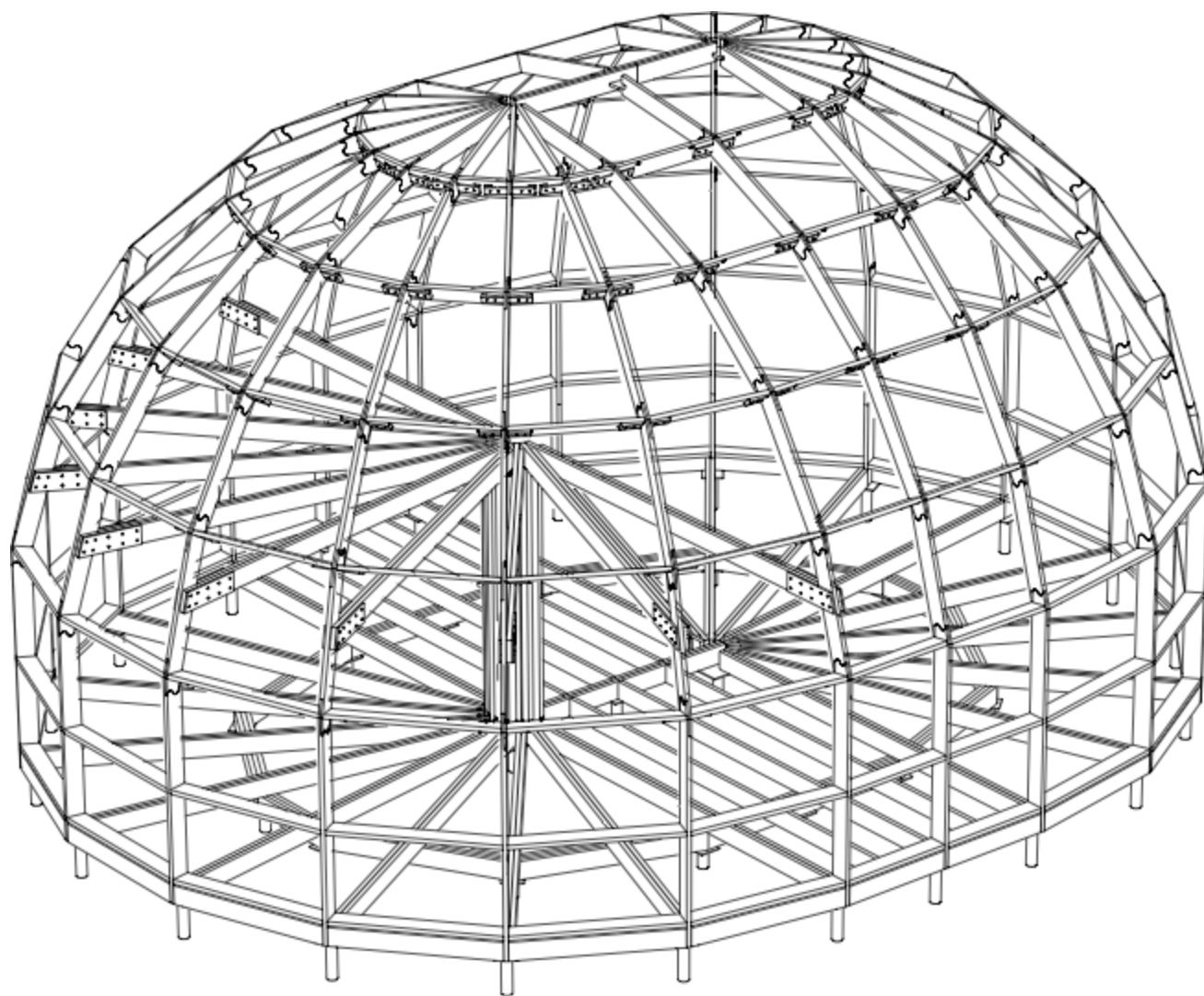













Z10HL



DOBROSFERA

Delivery set

Co de	Picture	Amount
B1		22 pieces
B2		88 pieces
B3		22 pieces
R1		36 pieces
R2		18 pieces
R3		18 pieces
R4		18 pieces
R5		18 pieces
R6		18 pieces
C1		8 pieces
C2		20 pieces
V1		2 pieces
V2		2 pieces

VN		1 piece
D		2 pieces
N		154 pieces

A foundation piles, foundation frame, floor lags, flooring beams, supports and anchorages of the lags of the second floor are not included in the delivery set.



Attention! Be sure to read this section before assembling.

Before proceeding with the assembly of the frame, prepare sawn OSB elements, 15 mm thick (map of pattern see below), a screws, a screwdriver and drills for pre-drilling under self-tapping screws. All of this you will need during assembly.

During assembly, be sure to fix a frame, securing the cladding on each assembled horizontal tier. The cladding, sawn exactly in size, is also a template for precise positioning of beams and the braces of the frame for correct convergence in the upper anchorage.

For installation of the cladding, please use galvanized screws 5x70 every 20 cm perimeter. To drill 3 mm by 53 mm deep into the frame.

To piece together the constituent elements of the cladding, consisting of several parts is required.

Nagel must be attached to the braces with bolts and nuts and with washers as indicated in the instructions.

The frame must be fixed on metal plates on top of the pile with a bolt screw from below through the head to the vertical beam with preliminary drilling with a depth of 120-150 mm.



It is important!

Never pick up the next horizontal tier of the frame, without securing the previous covering!

Remember that this can lead to collapse of the frame, serious injuries and even death. Strictly adhere to the assembly instructions!

For work at a height, use only specialized auxiliary equipment. Be sure to use a construction helmet, insurance and assistants.

If you are not sure in your abilities, recruit specialists for installation.

Foundation - screw piles

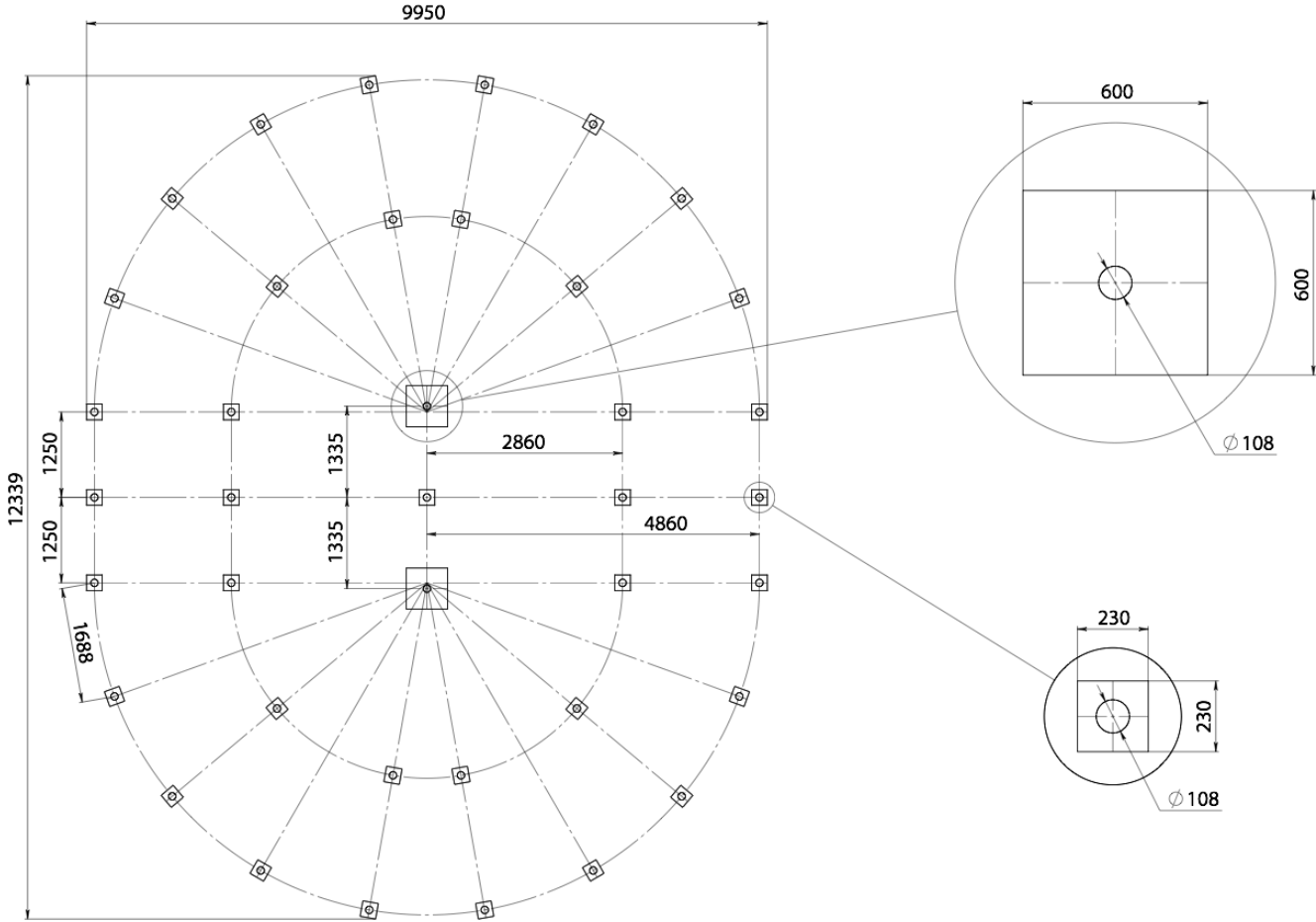

It is possible to use a band or monolithic foundation; combining of perimeter piles and concrete support in the center; other types of foundations.

Foundation frame and lags of the first floor

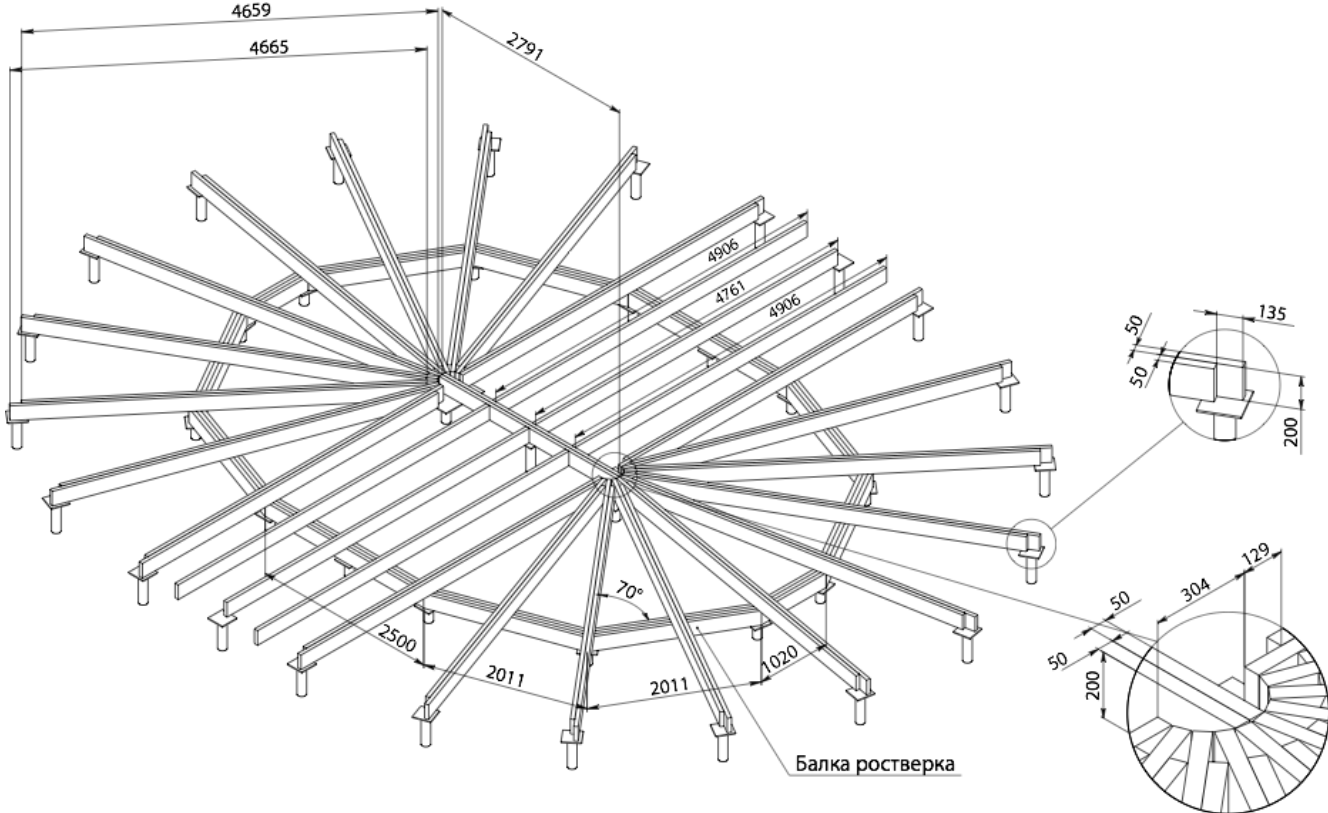

The lags of floor and the beams of foundation frame are not included in the delivery set, they are locally manufactured from dry lumber.

Frame assembly and nagels

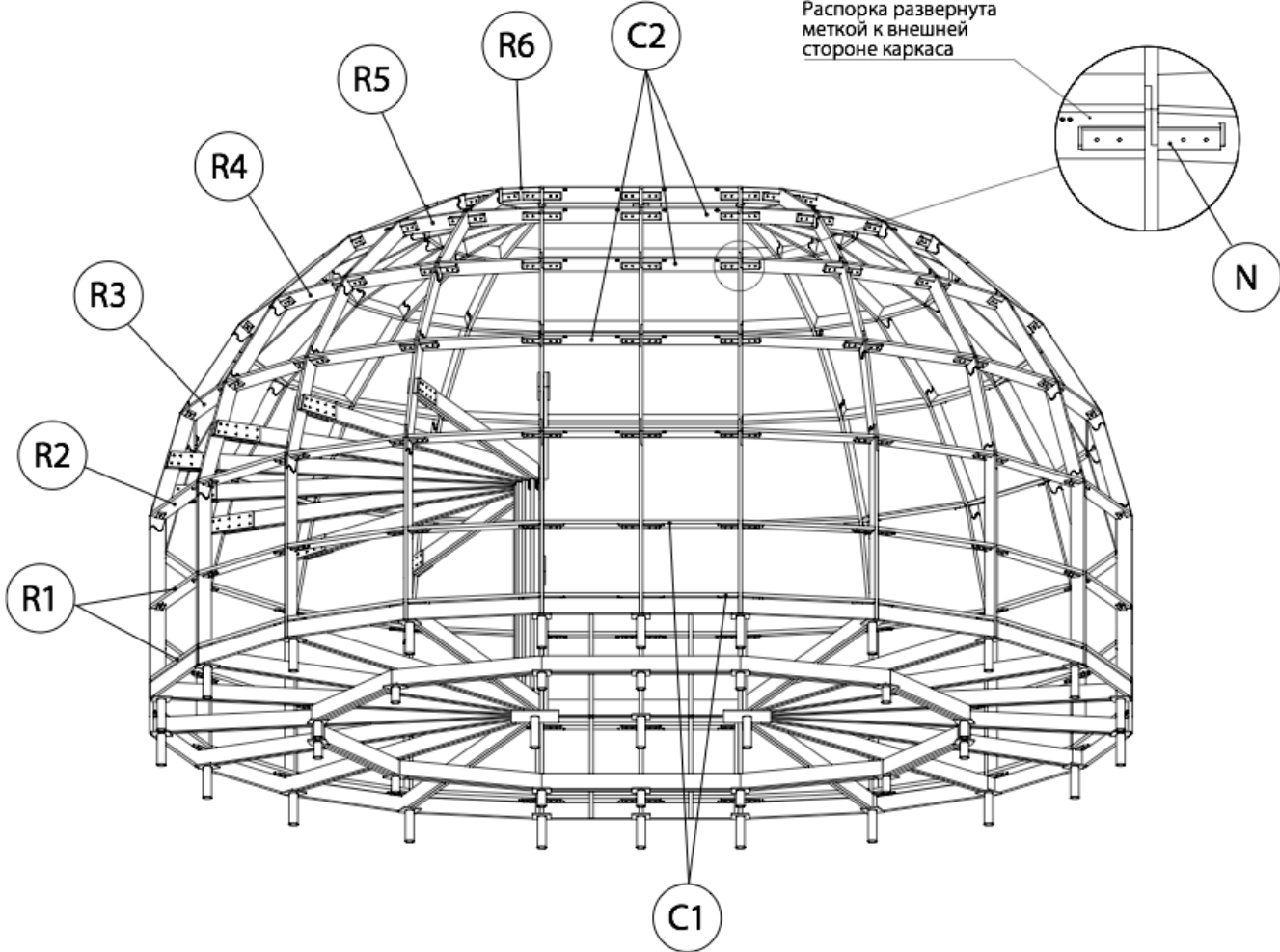

Drill through the nagel and the brace. The holes and their location are shown in the figure. Fix the brace and the nagel with a bolt M12 bolt with a nut and wide washers on both sides. A total of 4 bolts per each nagel.



Frame assembly. Support disk

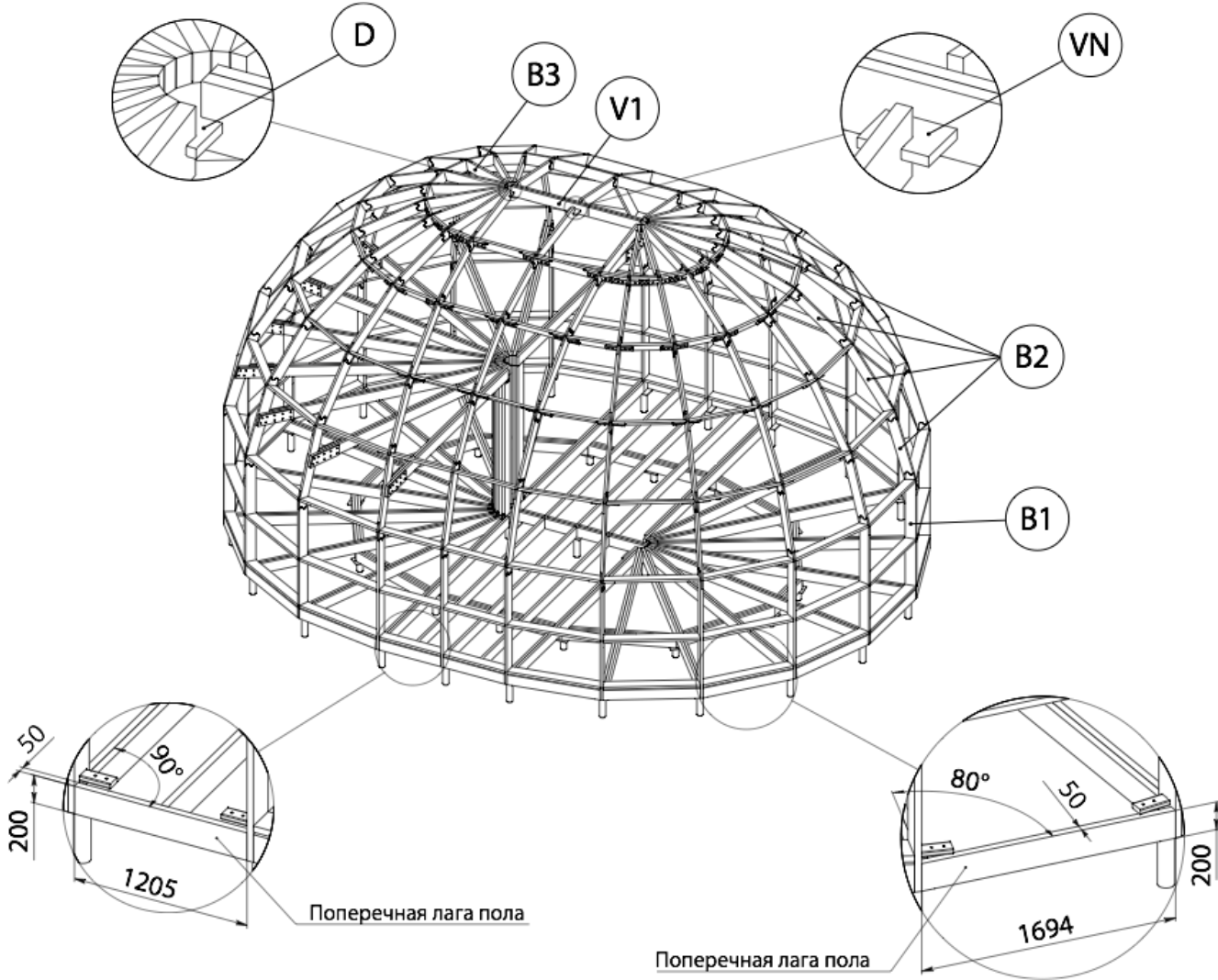

Assembly of units

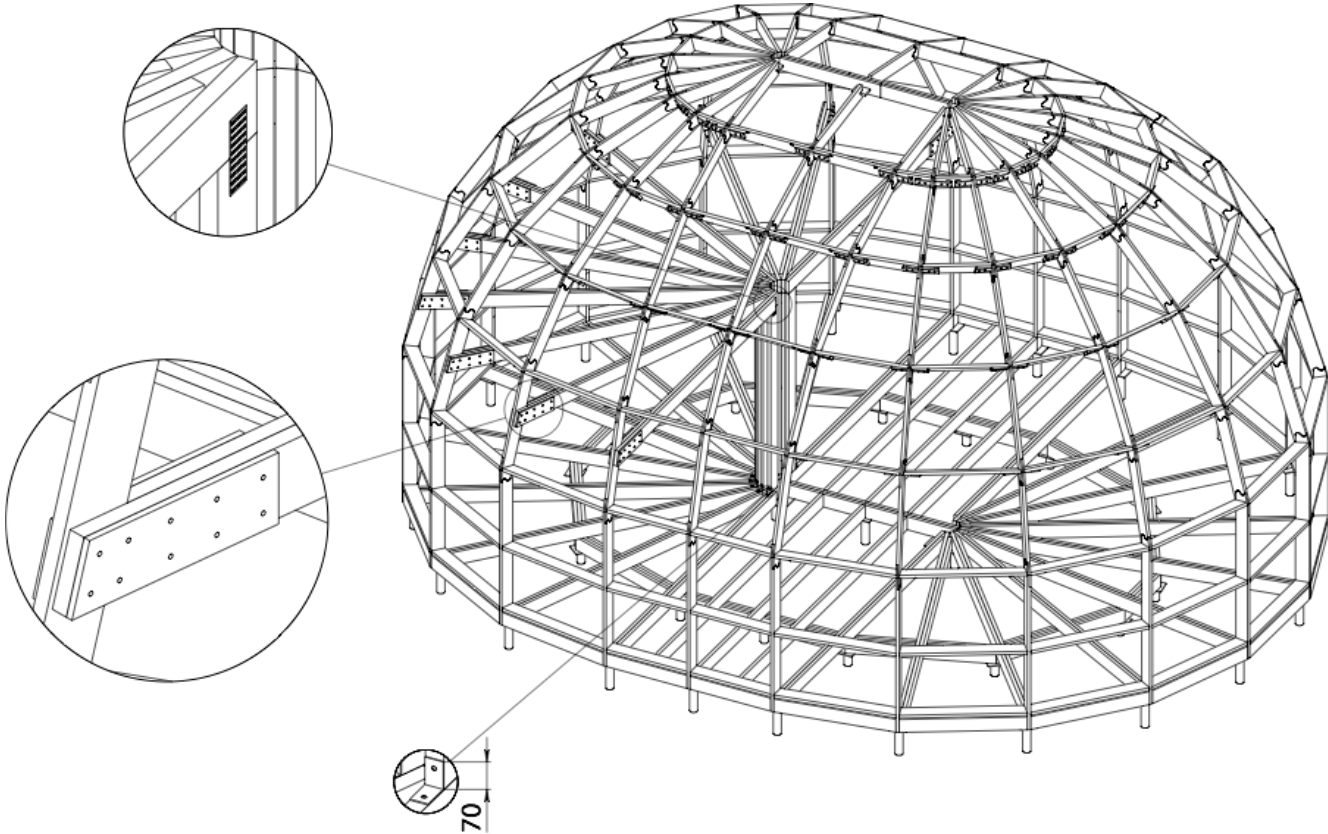

Fixing lag of the floor on the second floor with support

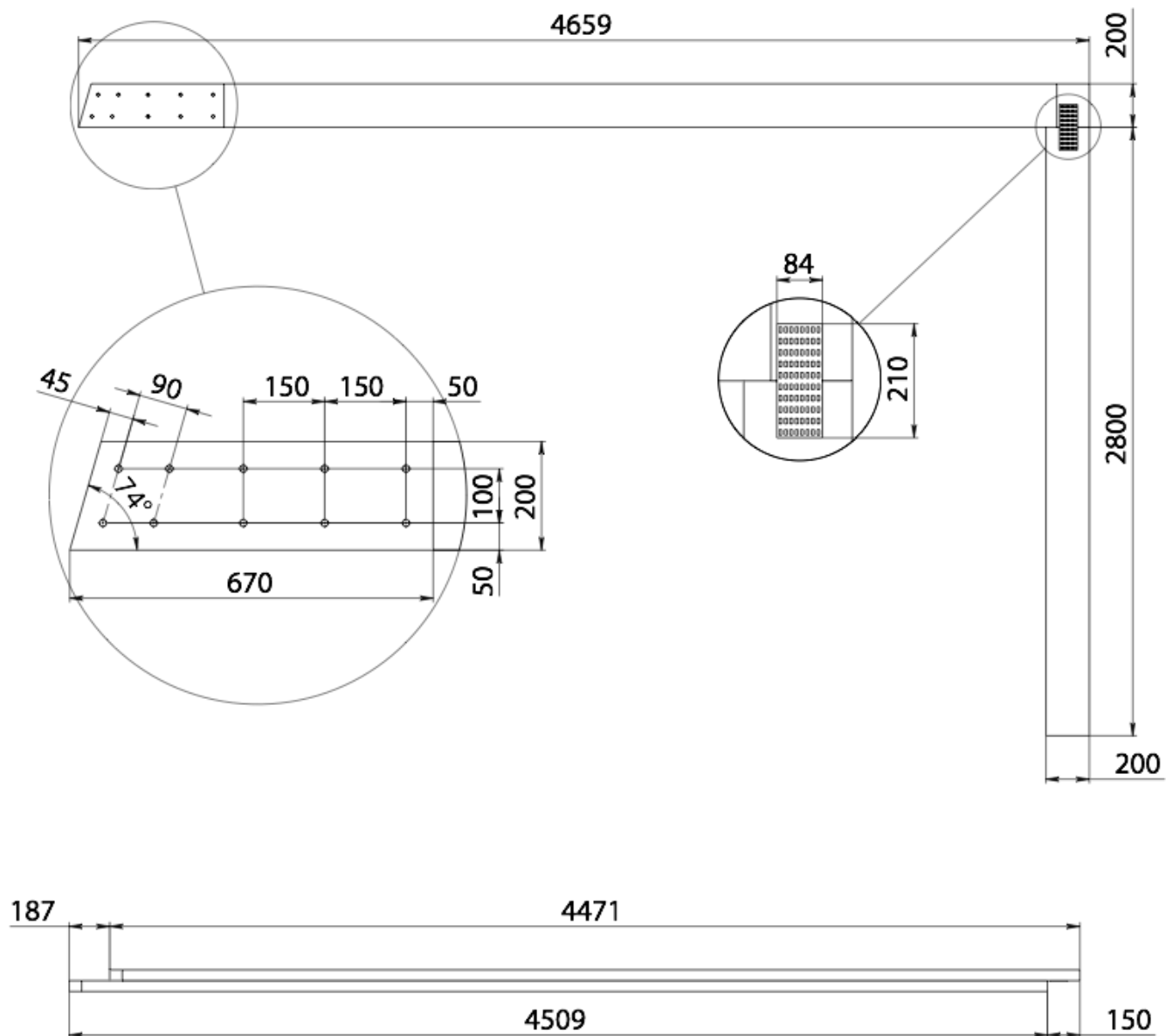

Supports of the lags of the floor and the lags of the second floor are ordinary boards of coniferous trees. Fixing lining are made of PSF plywood thickness of 30 mm. We recommend to leave a sufficient second light to organize the stairs and maximum aesthetics of the construction. To avoid sagging the lags of the second floor, add vertical supports under the lags to the wall partitions and other places as needed.

Upper beam

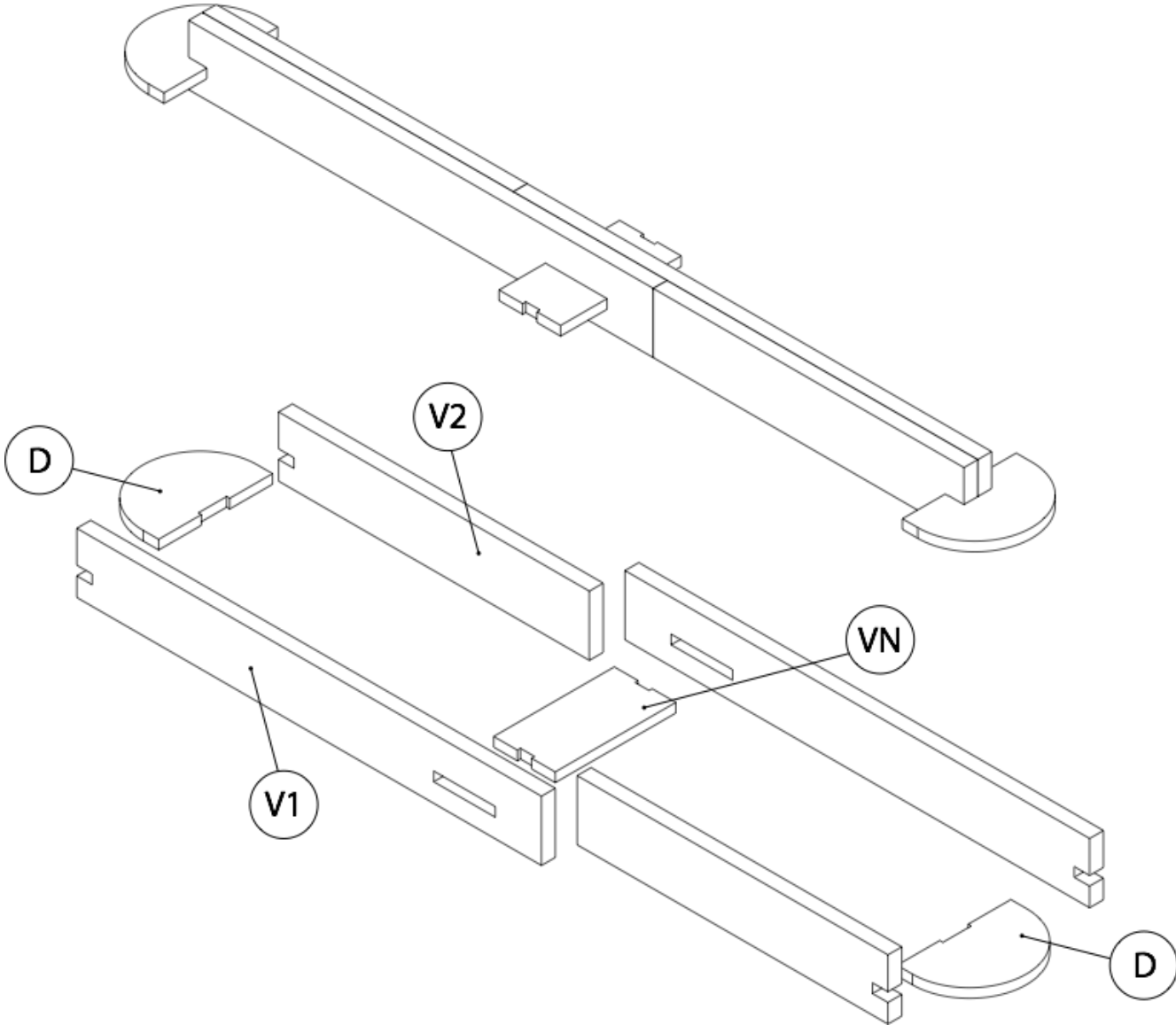

Sheet of frame cladding

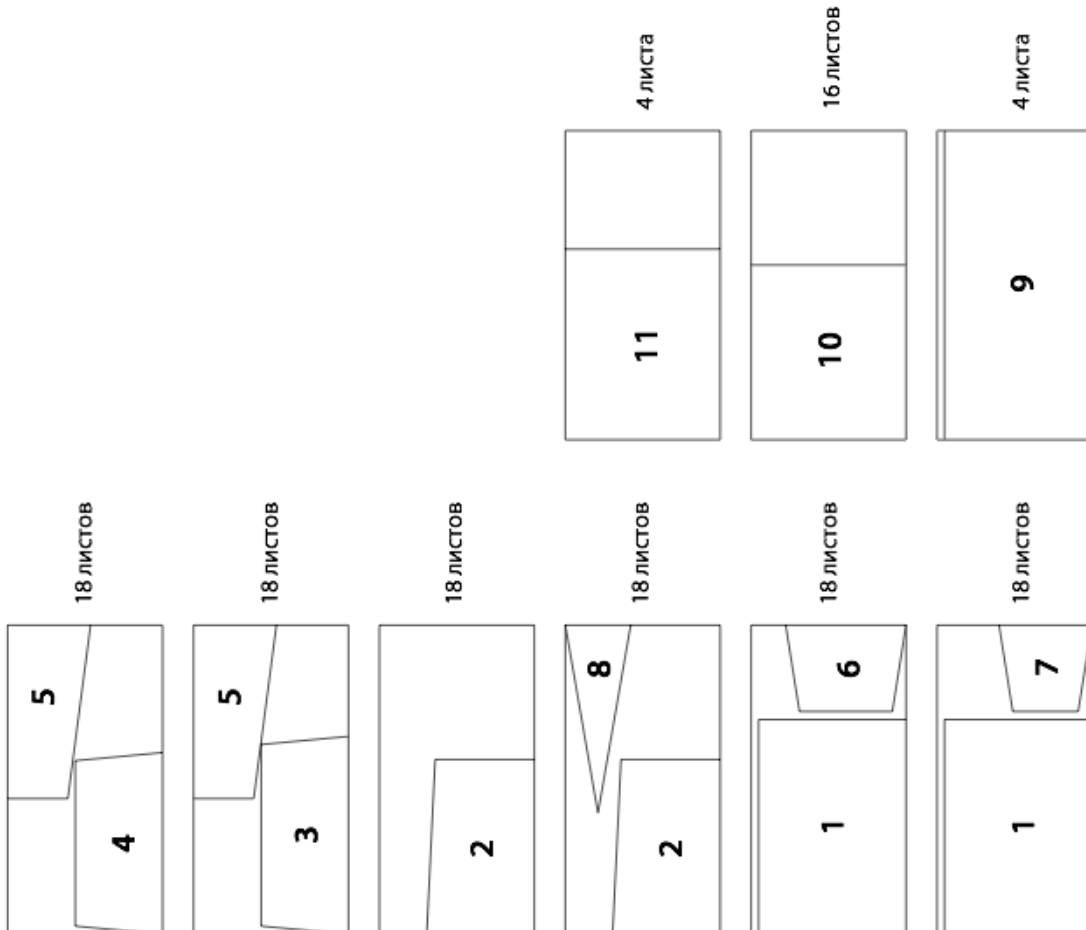
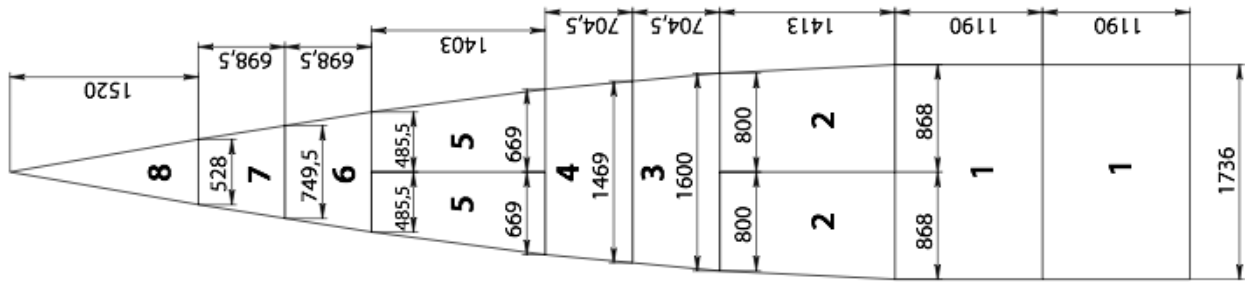
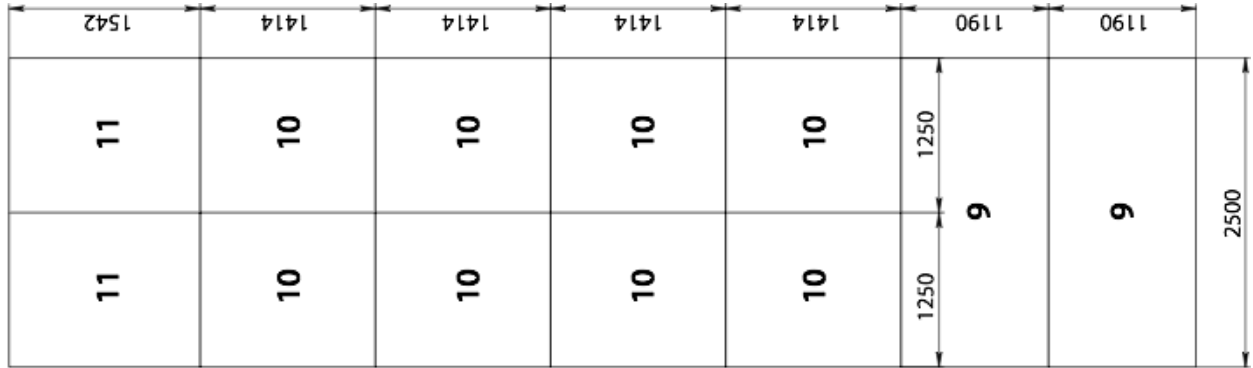

Presented for OSB size 15x1250x2500. Trimming of the material will go to underfloor heating and for the connecting bar. In the process of connecting the composite elements by the bar, do not allow the output of the screws from the outside of the cladding - otherwise it will damage the roof! Sheathing is not included in the delivery set and it is manufactured independently.

Important notes

The constructor is made of solid wood of coniferous trees - a living, natural material.

The presence of irregularities, knots, roughness and cracks in the frame elements is acceptable, which is not a material defect and does not affect the strength of the construction.

Features of storage and the maintenance

The constructor should be used for its intended purpose as a dome house, which is lined from the outside and roofed with a roof.

It is recommended to cover all wooden frame elements with a protective formulation, selected according to the planned operating conditions.

You should keep the constructor in a cool dry place, protected from direct sunlight and precipitation, ensuring free circulation of air around the elements, away from heat sources, high humidity and extraneous odors.

The guarantee

The manufacturer sets a warranty period of one year for the constructor. At the same time, the change in the physical parameters of the designer (wood) arising from improper storage or operation is not a warranty case.

Reference information

The table shows the characteristics of the constructor Dobrosfera Z10HL for an approximate calculation of the estimate.

№	Наименование	Unit of meas.	Quantity
1	Total surface area	m ²	258
2	The area of the vertical part	m ²	87
3	Surface area of the dome	m ²	171
4	Quantity of OSB sheets for cladding	pieces	132
5	Quantity of self-tapped screws for cladding	pieces	4096